

smartline

320 / 420 / 600 / 800

Installation, Operating and Servicing Instructions



INDEX

WARNINGS	3
Who should read these instructions	3
Symbols	3
Recommendations	3
Applicable standards	3
Warnings	3
Packing	3

INTRODUCTION	4
Description of the specifications	4
Description of operation	4

TECHNICAL CHARACTERISTICS	5
Operating condition	5
Wiring diagram	5

INSTALLATION INSTRUCTIONS	6
Dimensions	6
Domestic hot water connections	6
Installation	6
Central heating connections	7

COMMISSIONING	8
Filling the tank	8
Check to be carried out before start-up	8
Setting the thermostat	8

MAINTENANCE	9
Periodic checks by the user	9
Annual service	9
Emptying	9

SPARE PARTS	10
--------------------	-----------

WARNINGS

WHO SHOULD READ THESE INSTRUCTIONS

These instructions should be read by:

- the specifying engineer
- the installer
- the user
- the service engineer

SYMBOLS

The following symbols are used in this manual:



Essential instruction for the correct operation of the installation.



Essential instruction for the safety of persons and the environment.



Danger of electrocution.



Danger of burns

RECOMMENDATIONS



- Please, read carefully this manual before installing and commissioning the tank.
- It is prohibited to carry out any modifications to the inside of the appliance without the manufacturer's prior and written agreement.
- The product must be installed and serviced by trained engineers, in compliance with current standards.
- The installation must comply with the instructions in this manual and with the codes and standards governing systems for the production of hot water.
- Any failure to follow instructions relating to tests and test procedures may result in personal injury or risks of pollution.
- To guarantee safe and correct operation of the appliance, it is important to have it serviced and maintained every year by an approved installer or maintenance company.
- In case of anomaly, please call your service engineer.
- The parts may only be replaced by genuine factory parts. You will find a list of the spare parts and their reference number ACV to the end of this document.



- It is important to switch the tank OFF before carrying out any work.
- There are no user accessible parts inside the tank casing.

APPLICABLE STANDARDS

The appliances carry the **CE** mark in accordance with the standards in force in the various countries.



WARNINGS

This documentation is part of the information delivered with the appliance and must be given to the user and stored in a safe place!

An approved installer must carry out the assembly, commissioning, maintenance and repair of the system, in accordance with current standards in force.

ACV shall not accept any responsibility for damage caused by non-compliant location of the system or by use of the parts or connections not approved by ACV for this application.



The manufacturer reserves the right to change the technical characteristics and specification of its products without notice.



The availability of some versions and their accessories is market dependant.

PACKING

Units are shipped ready to install, tested and packaged in a cardboard box.

Contents of the package

- One hot water tank.
- One multilingual technical instruction manual.

INTRODUCTION

DESCRIPTION OF THE SPECIFICATIONS

"Tank-in-Tank" system

"Tank-in-Tank" is a heat exchanger with a built-in accumulator, made up of two concentric tanks: the inner tank contains domestic water to be reheated (secondary) and the outer tank contains the heating fluid (primary) which circulates between the two tanks and transfers its heat to the domestic water.

Hot water exchanger accumulator

The inner tank is the heart of the tank: it is subject to the aggressiveness of the supply water, to high pressures and to variations in temperature. This tank is made of solid chrome-nickel stainless steel (*stainless steel 304 or duplex*), fully welded under argon protection using the Tungsten Inert Gas (T.I.G.) technique.

Before assembly, the convex bottoms are pickled and passivated in order to improve the tank's lifespan and in particular its resistance to corrosion. The shell is corrugated all the way up using an exclusive manufacturing process. This design gives considerable resistance to pressure and limits the adherence of lime scale by allowing the tank to expand and contract.

Outer tank

The outer tank containing water from the primary circuit arriving from the boiler, is made of carbon steel STW 22.

Thermal Insulation

This is carried out using high density injected polyurethane foam, 50 mm containing no CFCs.

Lining

The tank is covered using polypropylene, a plastic material which offers a high resistance to shocks and which is also very pleasing to the eye.

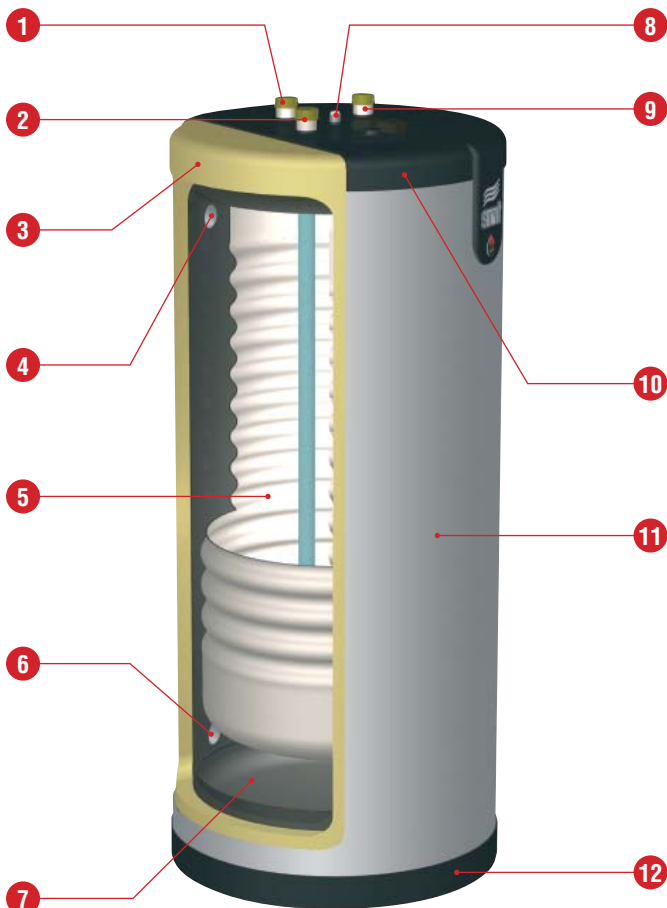

DESCRIPTION OF OPERATION

Operating cycle

The thermostat is triggered and starts up the pump which loads the heating fluid. This fluid circulates around the inside tank and heats up the domestic water. When the required temperature is reached, the thermostat stops the loading pump.

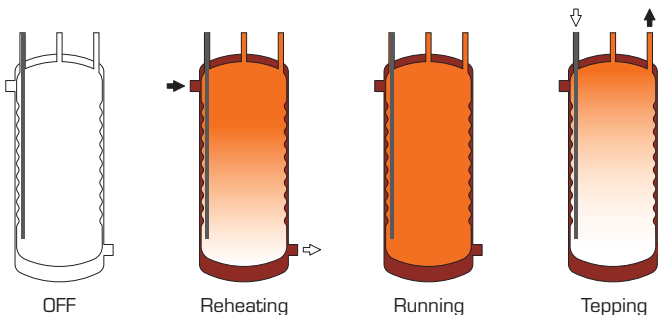

□ Cold Water

■ Domestic hot water

■ Heating fluid

Losses when shut down in Watt

Models		Losses in [Watt]
SL 320	$\Delta T = 50 \text{ K}$	94,4
SL 420	$\Delta T = 50 \text{ K}$	102,8
SL 600	$\Delta T = 50 \text{ K}$	110,5
SL 800	$\Delta T = 50 \text{ K}$	121,7

Temperature losses with ambient T° of 20°C

1. Auxiliary connection DHW
2. Domestic cold water inlet
3. Polyurethane foam insulation 50 mm
4. Flow connection [primary circuit]
5. Stainless steel (304 or Duplex) inner tank
6. Return connection [primary circuit]
7. Outer steel tank [primary circuit]
8. Manual air valve
9. Domestic hot water outlet
10. Polypropylene top lid
11. Polypropylene shell
12. Polypropylene bottom lid

TECHNICAL CHARACTERISTICS

OPERATING CONDITION

Maximum service pressure [tank filled with water]

- Heating circuit: Smart 320 / 420 / 600 / 800 4 bar
 Smart 320 / 420 Duplex 6 bar
 Smart 600 / 800 Duplex 5 bar

- DHW circuit: 10 bar

Operating temperature

- Maximum temperature: 90°C

Water quality

- Chlorides: < 150 mg/L [304 Stainless steel]
 < 2000 mg/L [Duplex]
- $6 \leq \text{ph} \leq 8$

Tank characteristics		SL 320	SL 420	SL 600	SL 800
Total capacity	L	318	413	606	755
Primary capacity	L	55	55	161	184
Primary fluid flow rate	L/h	6200	6400	7200	7500
Primary pressure drop	mbar	90	95	92	175
Heating surface	m ²	2,65	3,24	3,58	4,36

Tank performances		SL 320	SL 420	SL 600	SL 800
Peak flow at 40°C	L/10'	922	1195	1345	1820
Peak flow at 45°C	L/10'	790	1012	1153	1474
Peak flow at 60°C	L/10'	504	620	706	948
Peak flow at 40°C	L/60'	2666	3151	3437	4039
Peak flow at 45°C	L/60'	2285	2608	2946	3263
Peak flow at 60°C	L/60'	1368	1513	1733	1811
Constant flow at 40°C	L/h	2093	2536	2511	2888
Constant flow at 45°C	L/h	1794	2058	2152	2347
Constant flow at 60°C	L/h	1037	1153	1232	1306
Pre-heating time	minutes	23	24	35	66
Puissance puisée	kW	73	88	88	96

Running conditions: 85°C

Water intake T°: 10°C

WIRING DIAGRAM

1. Control thermostat [60/90°C]
2. Load pump [in option]
3. Manual reset high limit thermostat [103°C max.]

B. Blue
 Bk. Black
 Br. Brown
 R. Red
 Or. Orange
 W. White
 Y/Gr. Yellow/Green

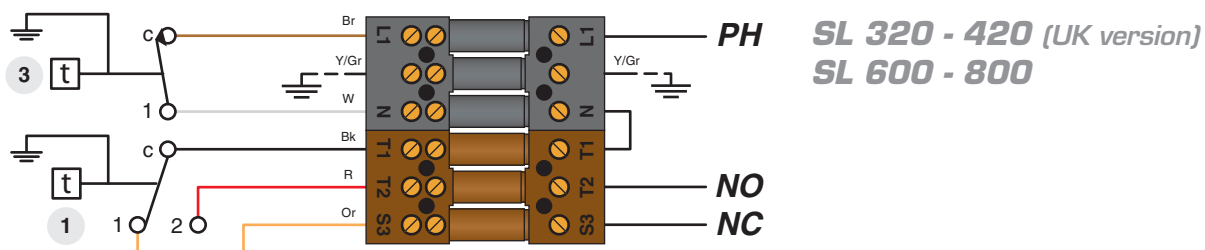
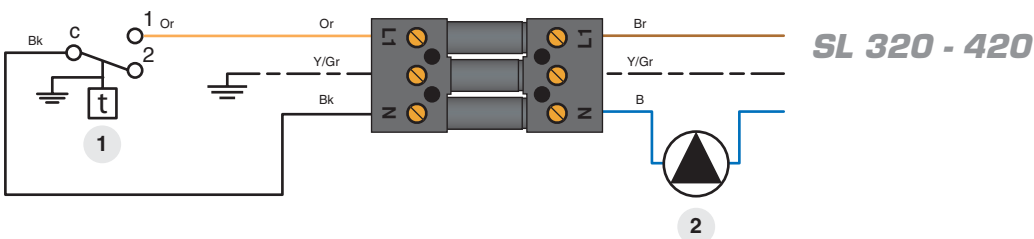

INSTALLATION INSTRUCTIONS

DIMENSIONS

	SL 320	SL 420	SL 600	SL 800
A mm	1593	2018	1892	2292
B mm	1280	1705	1583	1983
C mm	250	250	255	255
D mm	660	660	817	817
Weight empty [kg]	141	167	238	280

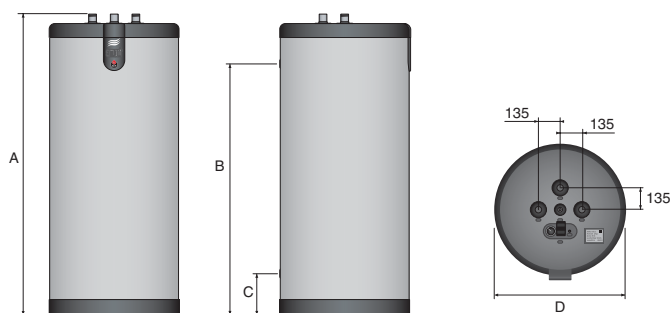

INSTALLATION

This hot water tank should not be installed where it will be exposed to outside weather conditions.

Choose the most appropriate location according to the position of the boiler and the proximity of the domestic hot water distribution system, in order to reduce heat losses and minimise the pressure drops.

Only for floor-standing installation.

HYDRAULIC CONNECTIONS

Models		Heating connections
SL 320 / 420	Ø	1"1/2 [F]
SL 600 / 800	Ø	2" [F]
Models		DHW connectons
SL 320 / 420 / 600 / 800	Ø	1"1/2 [M]

DOMESTIC HOT WATER CONNECTIONS

⚠ The installation of a domestic safety unit is compulsory. In order to avoid water dropping on the tank, the domestic safety unit should not be placed directly above the tank.

The third domestic water outlet can be used as a return from the domestic hot water circulation loop.

Mains water kits could be in some countries due to approval regulations.

Recommendations

- The pipe feeding the tank with cold water must be fitted with a safety unit comprising at least the following:
 - An isolating valve [1]
 - a non-return valve [3]
 - a safety valve [4]: *(set to < 10 bar)*
 - a sanitary expansion vessel of appropriate dimensions.
- When the operating pressure exceeds 6 bar a pressure reducer [2] must be installed before the safety unit.
- Union fittings are recommended for easy removal of the connections. Ideally the "dielectric" version is preferable in order to protect the connections against corrosion in the presence of dissimilar metals such as copper and galvanised steel.
- The installation of an expansion vessel avoids safety valve runoff (loss of water).
- Domestic hot water expansion vessel capacity:

18 Litres: for the following models:	320
24 Litres: for the following models:	420
35 Litres: for the following models:	600 / 800



Please see the technical instruction manual of the expansion vessel's manufacturer for further details.

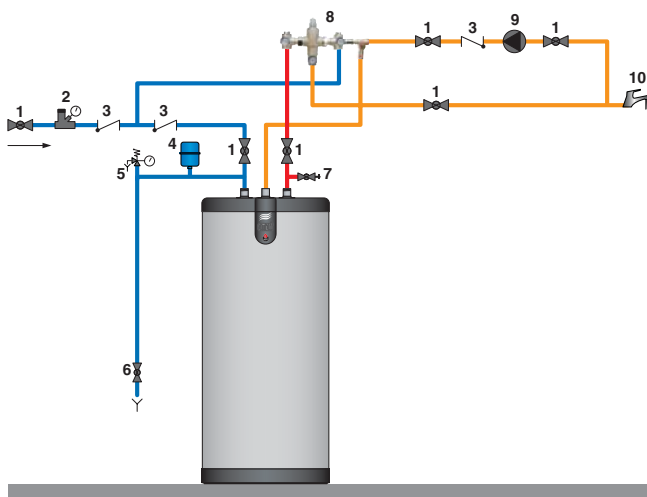

1. Isolating valve
2. Pressure reducer
3. Non-return valve
4. Expansion tank
5. Safety valve
6. Drain cock
7. Air vent
8. Thermostatic mixing valve
9. Circulation pump
10. Drawoff point

INSTALLATION INSTRUCTIONS

CENTRAL HEATING CONNECTIONS

1. System filling valve
2. Safety valve calibrated to 3 bar
3. Expansion vessel
4. Drain cock
5. Isolation valve, heating system
6. Room thermostat
7. Optional boiler control [BC O1 or BC O3]
8. Boiler pump
9. Heating pump
10. 3-ways motorized mixing valve

Tank with load pump

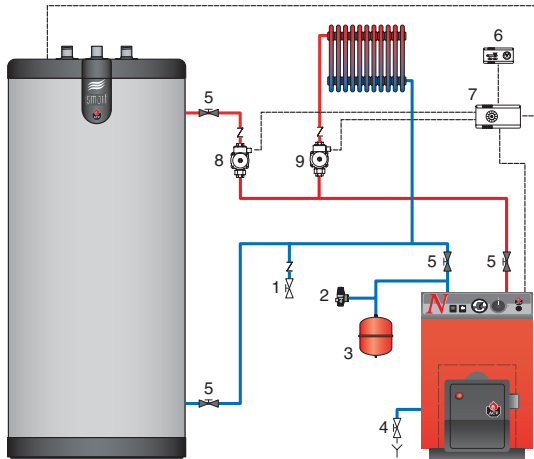

Tank with three ways motorized mixing valve.

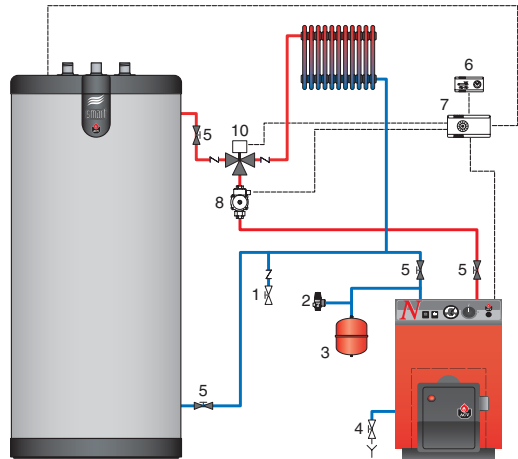

Battery formation of 3 indirect water heaters

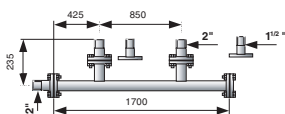
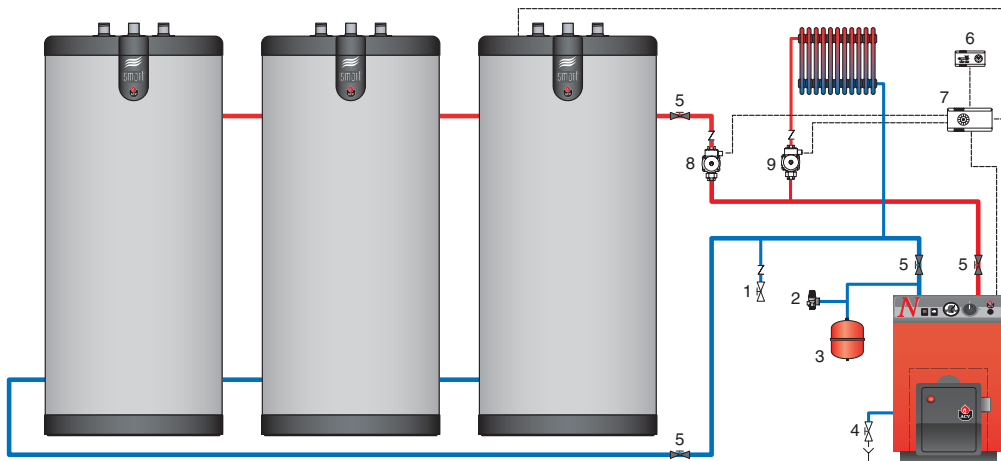

10800128

Kit battery 2x SL 320 - 420 - 600 - 800

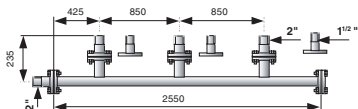

10800129

Kit battery 3x SL 320 - 420 - 600 - 800

COMMISSIONING



Before pressurising the central heating tank (primary) you should first pressurise the domestic hot water tank (secondary).

Both the domestic hot water tank and the central heating tank must be filled before using the tank.

FILLING THE TANK

Domestic hot water tank

1. Close the drain cock [6] of the DHW circuit.
2. Open the isolating valve [1] of the DHW circuit for the filling.
3. Bleed the air in the circuit by turning on a nearby hot water tap [10]. Fill the tank until the flow rate stabilises.
4. Turn off the hot water tap [10].

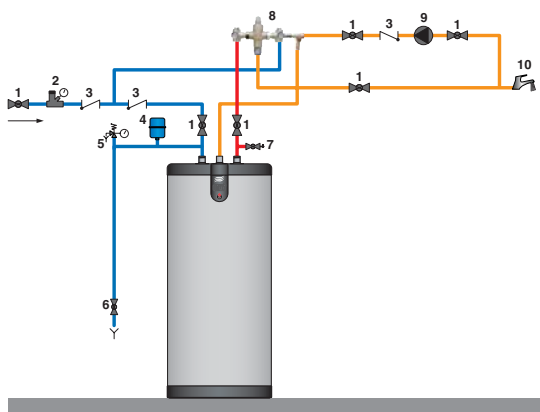

Central heating tank

1. Close the drain cock [4] on the tank's primary circuit.
2. Open the isolation valves [5] on the central heating circuit connected to the boiler.
3. Bleed the air in the circuit by opening the air vent located on the upper part of the tank.
4. Follow the instructions supplied with the boiler for filling.
5. When the tank is full and the air has been removed, the bleed valve should be closed.

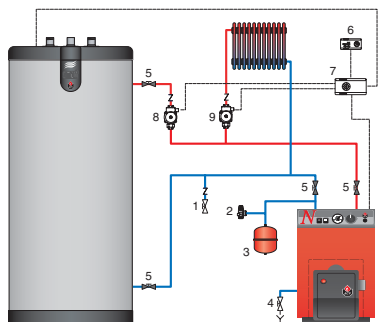

Ensure that the bleed valve is properly sealed.

6. If any antifreeze is needed in the primary circuit it must be compatible with Public hygiene rules and not be toxic. A food-type Propylene Glycol is recommended. Consult the manufacturer to ensure that the antifreeze is compatible with the tank's construction materials.



Never use car antifreeze or undiluted antifreeze. This can cause serious injury, death or damage to the premises.

CHECKS TO BE CARRIED OUT BEFORE START-UP

- Safety valves (domestic hot water) and (central heating) correctly installed and discharge connected to the drains.
- Domestic hot water tank and primary circuit filled with water.
- Air bleed correctly carried out on both circuits.
- Air valve sealed.
- Both hot and cold water pipes correctly connected to the tank's hot water circuit.
- Heating feed and return correctly connected to the tank.
- The electrical cabling is correct.
- The tank's thermostat is set according to the instructions shown in § "Setting the thermostat".
- Connections checked and free of leaks.

SETTING THE THERMOSTAT

Factory settings

The thermostat of the tank is factory preset to the minimum recommended by the standards, over a range of settings from 60 to 90°C.

To increase the temperature: turn the button clockwise.

To reduce the temperature: turn the button anticlockwise.

When adjusting the tank's thermostat, make sure that the boiler temperature is set to a value at least 10°C higher than tank's thermostat.

Recommendations



There is a risk that bacteria including "Legionella pneumophila" may develop if a minimum temperature of 60°C is not maintained both in storage and in the hot water distribution network.



There is a risk of scalding from hot water! ACV recommends the use of a thermostatic mixing valve set to provide water at 60 °C or less.

- The water heated to wash clothes, dishes and for other purposes can burn and cause serious injury.
- Children, the elderly, the sick or the disabled are the most at risk from burns due to very hot water. Never leave them on their own in a bath or under the shower. Never allow young children to turn on hot water taps or fill their own baths.
- Set the water temperature appropriately according to the intended use and plumbing codes.



When repeatedly drawing small amounts of hot water, a "stratification" effect may develop in the tank. The upper layer of hot water may then reach very high temperatures. A thermostatic mixing valve will stop water at excessively high temperatures reaching the outlets.

PERIODIC CHECKS BY THE USER

- Check the pressure of the boiler's pressure gauge: it should be between 0.5 and 1.5 bar.
- Carry out a monthly visual inspection of the valves, connections and accessories in order to detect any leaks or malfunctions.
- Periodically check the air valve located on the upper part of the tank to make sure that it is not leaking.
- If you notice anything unusual, contact a technician or your heating engineer.

ANNUAL SERVICE

The annual service, carried out by a technician, must include the following:

- Checking the air valve:
The air bleed can lead to water being added to the system. Check the pressure on the boiler's pressure gauge.
- Manually activate the domestic hot water safety valve once a year. This operation will lead to a discharge of hot water.



Before drawing any hot water through the safety unit, make sure that the discharge goes directly to the drain in order to avoid any risk of burning or damage.

- The discharge pipe should be open to the atmosphere.
- If the safety unit occasionally "drips" this may be due to an expansion problem or to clogging of the valve.
- Follow the circulator's maintenance instructions.
- Check that the valves, cocks, controllers and any electrical accessories installed are working properly (*see the manufacturer's instructions if necessary*).

EMPTYING

Recommendations



Empty the tank if it is to be switched off during the winter and there is a risk of frost conditions exposure.

If the central heating water (primary circuit) contains any antifreeze, only the domestic hot water should be drained.

Before draining off the domestic hot water, insulate the tank to reduce the central heating pressure (primary circuit) to 1 bar, in order to protect the tank against a risk of collapsing.

If the central heating circuit does not contain any antifreeze, both the central heating and hot water circuits should be drained.

Domestic hot water tank

To empty the domestic hot water tank:

1. Switch off the electrical power supply to the tank.
2. Close the isolation valve [1].
3. Open the drain cock [6] and the air vent [7].
4. Allow the water to flow out into the drain.
5. After emptying, return the valves to their initial positions.



In order to allow emptying, the drain valve [6] must be located at the lowest point on the tank.

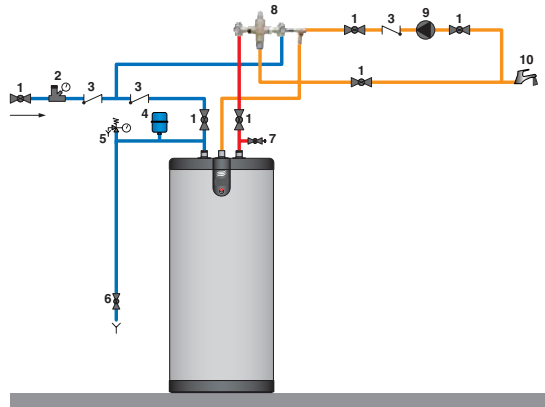

Central heating tank

To empty off the primary circuit:

1. Switch off the electrical power supply to the tank.
2. Close the shut-off valves [5] on the primary circuit.
3. Connect a hose to the drain valve [4].
4. Open the drain valve [4] and drain the hot water off.
5. To speed up the process, open the air vent located on the upper part of the tank.
6. When the emptying is finished, close the drain cock again then screw the air valve up again.

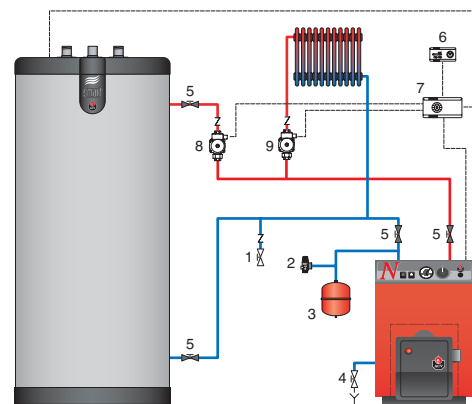

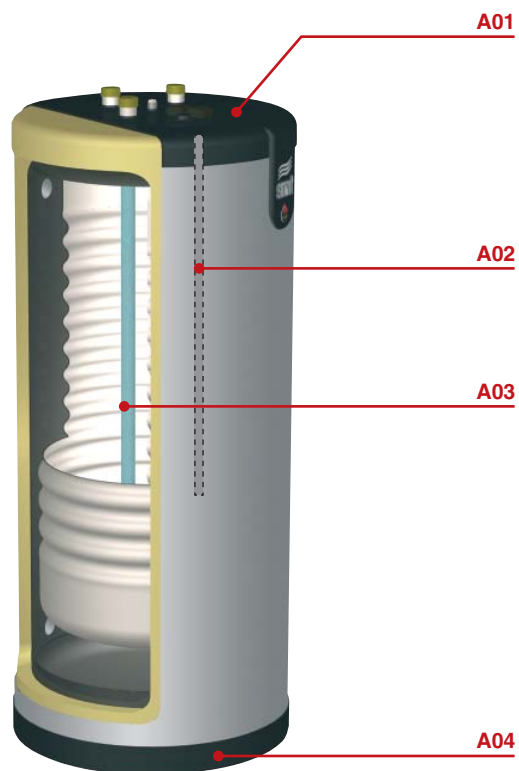







N°	SL 320	SL 420	SL 600	SL 800
A01	497B5001	497B5001	497B5007	497B5007
A02	39438047	39438049	39438030	39438049
A03	49410089	497B0029	49410044	497B0029
A04	497B5000	497B5000	497B5006	497B5006

SL 320 - 420

SL 320 - 420 (UK)
SL 600 - 800

	55445006	55445006
	54442045	54442045
	54764021	54764021
	24614154	—
	—	54764020
	—	24614152